

# Türkiye

## TET Trade Delegation to SLOVAKIA-AUSTRIA

### B2B Meetings

Vienna | May 27th, 2024  
Bratislava | May 29th, 2024

### Participant Catalogue

White Goods 

Electronics 

Cables 

Electricity Production and  
Distribution Equipments 



ELECTRICAL AND ELECTRONICS  
EXPORTERS' ASSOCIATION



**ELECTRICAL AND ELECTRONICS  
EXPORTERS' ASSOCIATION**



## Technological Advantages

- Efficient and up to date equipment capacity
- Production flexibility
- Production capacity in international standards
- Strong industrial structure
- Product diversity
- Well trained and experienced work force



## Geographical Advantages

- Short time of delivery
- Neighboring the largest markets in the world
- Largely suitable for both land and marine transportation
- Well developed logistics network



## Market Advantages

- An appealing conjuncture for both foreign and domestic capital investments
- EU Customs Union Membership
- Increased competitiveness in international markets
- New employment opportunities
- Start-up friendly legal arrangements
- Increased domestic market demand



# ABOUT **TET**

Turkish Electro Technology Exporters' Association (TET) is a semi-governmental agency which promotes trade activities of its members. It was founded on 1991 and it is subjected to Ministry of Trade.

We, as TET, are working for our 7.000 active member companies in order to improve trade volume and cooperation opportunities of electrical and electronics industries.

# ACTIVITIES OF TET



## CO-OPERATION

Developing co-operations with international institutions



## FAIRS

Organizing and participating in trade fairs



## DELEGATIONS

Arranging "Trade Delegations" & Organizing "Buying Missions"



## MONITORING & REPORTING

Monitoring and providing sectoral data, reports and market research analysis

**Türkiye**



# INDEX

	BETA ENERJİ VE TEKNOLOJİ A.Ş.	6
	CANOZAN PANO SAN. TAAH. VE TİC. LTD. ŞTİ.	8
	CEFA MAKİNA SAN. TİC. A.Ş.	10
	ENTES ELEKTRONİK CİHAZLAR İMALAT VE TİCARET A.Ş.	12
	İLK-EL ELEKTRİK PANO SAN. VE TİC. LTD. ŞTİ.	14
	KENDAL ELEKTRİK AYD. ELEKTRONİK İNS. SAN. DIŞ TİC. A.Ş.	16
	KIRIÇ METAL ÜRÜNLERİ SAN. VE TİC. LTD. ŞTİ.	18
	ÖREN KABLO PAZARLAMA TİCARET LTD. ŞTİ.	20
	PAMİR ELEKTRİK SAN. VE TİC. LTD. ŞTİ.	22
	SOLEN KABLO SANAYİ VE TİCARET A.Ş.	24
	TEM TEKNİK ELEKTRİK MALZEMELERİ SAN. VE TİC. A.Ş.	26
	TEMKA KABLO İNŞ. SAN. VE TİC. LTD. ŞTİ.	28
	TİMSAN TRANSFORMATÖR SAN. VE TİC. LTD. ŞTİ.	30
	TRAFOMAKS TRANSFORMATÖR SANAYİ VE TİCARET LTD. ŞTİ.	32

## ABOUT US

Electric-Electromechanical sector as its target for many years, is a strong and respected technology company operating in the field of Power, Distribution and Special Winding Transformers, including Oil and Dry Types. Its main field of activity is the production of Oily and Dry Type Distribution Transformers, Power Transformers and Special Winding Transformers, with the quality, design and manufacturing standards of TSE, CE, SONCAP, ICMET, KEMA, TS 267, CEI/IEC 60076, BS 171, ANSI, ISO 17025, ISO90001, ISO14001, ISO18001, ISO50001 with a monthly production capacity of 750 units.

## PRODUCTS AND SERVICES

- Oil Immersed Transformer
- Dry Type Transformer
- Power Transformer
- Special Design Transformer
- Concrete Kiosk
- AC & DC Charging Stations



+90 (322) 394 42 55  
s.oezel@beta-elektro.com  
<https://betatransformer.com>





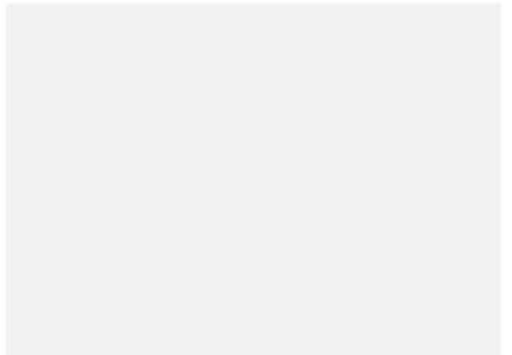

# CANOZAN PANO / WEPAN

## ABOUT US

CANOZAN is established in 1986 on the sector of electrical assembled panels. Panels of CANOZAN are used in hundreds of different projects as low voltage distribution, mcc-automation, and compensation panels. R&D department develops product range of industrial panels and cabinets according to feedback and request of domestic and overseas customers.

CANOZAN has 3.000 m<sup>2</sup> closed of 6.000 m<sup>2</sup> total facility area for production, test center, warehouse. Product of WEPAN is continuously developed solution of electrical assembled processes and follows international standards. CAD-CAM production process, CNC manufacturing machines and robotic powder coating process are for the computer integrated production for standardized of production quality. WEPAN has standard of IEC 61439-1-2 and protection class of form IP 42 to IP 66. Panels and enclosure is increased added value with these test and certificates in the sector. WEPAN continuously develops solution for sector of electrical assembled panels and improved goal of customer satisfy with professional staffs that have certificate of ISO 9001-2008.

## PRODUCTS AND SERVICES

- Low voltage cabins,
  - MCC automation,
  - Compensation,
  - Building distribution,
  - Network UPS boards,
  - IT boards,
  - 19 "Rack cabins,
  - CCTV boards,
  - External Enclosures,
  - Control control units,
  - PLC control panels,
  - Stainless steel panels,
  - Heating - Cooling systems,
  - Lighting accessories,
  - Cabinet, mounting accessories
- include a wide variety of services.



+90 (232) 853 7522  
ozan@canozanpano.com.tr  
nisa.basar@wepan.com.tr  
<https://www.wepan.com.tr>





# GENPOWER GENERATOR

## ABOUT US

Genpower Generator, which started its activities in Ankara OSB in 2001, has been providing service to meet all energy needs since its establishment. It continues to offer the most reliable form of uninterrupted energy to its solution partners for 21 years through its state-of-the-art products.

Genpower Generator has a wide import network of up to 120 countries with a 100% domestic and national production approach. Moreover, it has the feature of being the "world's largest generator factory" with its factory built on a 216,000 m2 land and with a 51,000 m2 closed area. It is one of the leading manufacturers in Türkiye and the world, with its state-of-the-art production system and a generator production capacity of 60,000 units/year in its current factory environment.

Genpower employs cutting-edge technology to produce a wide range of diesel and gasoline generators from 1 KVA to 3300 KVA along with welding generators, light tower generators, water pump generators, alternators, and synchronized systems, all characterized by efficiency and cost-effectiveness.

Genpower Generator's widespread recognition, both domestically and globally, underscores its commitment to innovation and excellence in addressing power needs.

## PRODUCTS AND SERVICES

- From 1 kVA to 3300 kVA
- Diesel Generators
- Portable Generators (Diesel & Gasoline)
- Light Tower
- Welding Generators (Diesel & Gasoline)
- Water Pumps



+90 (312) 310 38 28  
m.ozturk@genpower.com.tr  
www.genpower.com.tr



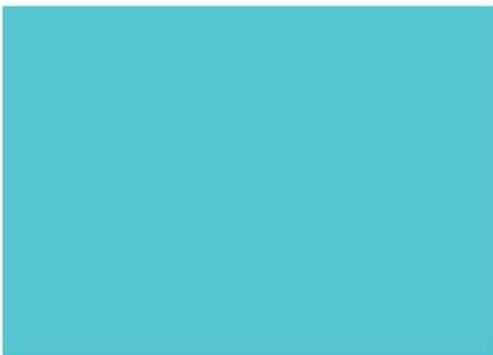

## ABOUT US

ENTES is an European technology company that works ardently since 1980 to manage the energy where energy is valuable and overcosting.

As one of the leading enterprises in shaping the way of conducting business, ENTES transforms energy into a manageable concept so that business can be conducted at the lowest cost, thus providing new economical opportunities.

Based on its own resources, ENTES takes advantages of qualified brain power and hard work with an aim of being pragmatic and also open to technological developments in the world. Hundreds of thousands of companies around the world manage the energy by using ENTES solutions.

Consistent growth since 1980 the year it was founded, High quality standards and international certificates in world classification, Experience for overseas markets over 107 countries and a worldwide-recognized brand in the industry with office in Germany, Greece and India, Powerful and accredited "Research and Development Centre" in the fields of Energy Efficiency and Quality, Yearly 120 person/hour function, 2640 person/hour type, 480 person/hour field tests applied for each new device at R&D level, Yearly 2,000,000 devices production capability in production plants with 12,000 m<sup>2</sup> closed area where state-of-the-art technologies are used.

## PRODUCTS AND SERVICES

- Power Quality & Energy: Digital Network Analyzers
- Electrical Measurement: Multimeters & Electrical Measurement devices
- Power Factor Correction: Power Factor Controllers, Capacitors, Contactors, Thyristor Switches
- Remote Monitoring: Energy monitoring software (developed by our R&D Department)
- Protection & Control: Power Supplies, Phase Failure & Voltage Monitoring Relays, Time Relays, Astronomic Time Relays



+90 (216) 313 01 10  
kaydin@entes.com.tr  
zcozturkmen@entes.com.tr  
www.entes.eu





## ABOUT US

İLK-EL ELECTRIC Ltd. Co., founded in 1974, is a Schneider Electric Solution Partner and an approved Prisma panel builder since 2005. Operating from our own 3500 m<sup>2</sup> facility in Istanbul, we prioritize customer satisfaction by delivering fast and efficient solutions. We take pride in offering high-end quality products, incorporating cutting-edge technology, at competitive prices, leveraging our extensive experience in the electrical industry. Committed to stringent health and safety standards, we maintain an excellent safety record and ensure all employees adhere to best practices and current H&S legislation.

**Schneider Electric PrismaSeT:** For over 25 years, we have been manufacturing low voltage panels under the Schneider Electric license, fully compliant with IEC 61439 standards and certified to meet your panel demands.

**EvoSIS:** Our product group provides optimum and practical system solutions, offering integration and cost-effectiveness through high-quality materials and design.

**Metallic Enclosures:** With 50 years of panel manufacturing experience, we continually expand our product range and enhance quality using CAD/CAM controlled CNC machines. We specialize in producing aluminum and stainless-steel enclosures especially for external applications, in addition to standard painted sheet metal.

**Fiber Optic/OFS:** As an approved supplier for all the F/O hardware and cabinets, we provide F/O hardware and cabinets for the fiber optic infrastructure of **Turkish National Telecom**.

**Reverse Vending Machine (RVM):** Designed by our R&D department, our RVM machines have been deployed in 100 primary schools. Additionally, we have developed various smart city applications, including 500 train Token Machines for the Municipality of Istanbul.

## PRODUCTS AND SERVICES

- Certified Designer & Manufacturer of Low Voltage Switchboards
- Approved Supplier of Outdoor Cabinets for Telecom infrastructure
- Customized Kiosks, Vending Machine
- Turn-key solution provider for MCC, PLC, and SCADA systems
- **Brands:** PrismaSeT, BlokSeT, Socomec, Phoenix Contact, KlemSan
- **Certificates:** IEC 614539, IEC 60522, ISO 9001, ISO 14001, ISO 45001







# KENDAL ELEKTRİK

## ABOUT US

Kendal Elektrik was started its activities in the electrical materials industry in 1998. Today we are working with 180 staff in area of 22.000 sqm. Kendal Elektrik is 100% Turkish capital and produces it's products according to the world standards with automation-based latest technology machinery. Beside the LED Bulb, which is the main artery of the sector, it produces LED panels,LED spots and LED flood lights and has the privilege of offering many product groups that customers need in the market under one roof. Kendal Elektrik company is the biggest led bulb manufacturer of Türkiye and Middle East. Our led bulbs production capacity is 60 million pcs for a year.We are first and unique producer of the filament & rustic bulbs for Türkiye and Europe. Kendal Elektrik has been increasing its capability every year with its growing product range and the investments made accordingly and adds value to it's strength in the market.

## PRODUCTS AND SERVICES

We are producing lighting items like led bulbs, led panels, led flood lights, led spot light, led wall fixtures, led linear lights, led ceiling fixtures, led rail spot lights, led street lights, led wallwashers, led strip lights.



+90 (212) 251 77 90  
export@kendalelektrik.com.tr  
export2@kendalelektrik.com.tr  
www.kendalelektrik.com.tr



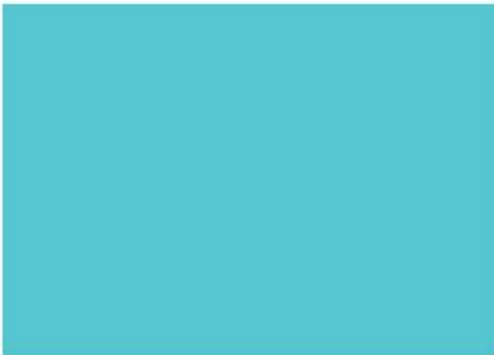

# KIRAÇ METAL

## ABOUT US

Kıraç Group, was established in 1982 with the vision to become a leading actor in the electrical market. The group includes separate entities titled as Kıraç Electricity, Kıraç Metal, Kıraç Otomasyon, Kıraç Galvaniz, Emcekare, Pioneer Metal, Kıraç Group İnşaat and Kıraç Bilişim interconnected with each other creating a culture of inhouse support across eight different sectors. The Group invests in the future by prioritizing customer satisfaction through top quality products and services it offers since its establishment. The Group is conducting successful operations in Europe, Asia, Middle East and North America.

Kıraç Metal Ürünleri San. ve Tic. Ltd. Şti. was established in 2002 in order to manufacture cable trays. The Company has completed successful projects with its experienced and dynamic team. Its main manufacturing facility is located in Eskişehir Organized Industrial Zone. The facility is established on a total area of 20,250 sq.m having an indoors space of 12,150 sq.m. With a manufacturing capacity of 1,000 Tones/Month, Kıraç Metal produces Solar Panel Handling and Mounting Systems, Cable Trays and Ladders, Supporting Components and Fittings plus Industrial-Type Electrical Panels. The facility is also designed to incorporate flexibility to adjust its manufacturing flow for tailored products. As one of the leading global manufacturers, Kıraç Metal is the choice of consumers for its high quality and customer oriented product and services, on time delivery policy and its pre/post-sales services. Kıraç Metal Ürünleri San. ve Tic. Ltd. Şti.'s primary export market is Europe while its products reach numerous other countries around the world.

## PRODUCTS AND SERVICES

- Steel Solar Mounting Structures for Ground.
- Solar Tracker Systems
- Carport Systems
- Solar Mounting Solutions for Roofs
- Cable Management Systems
- Metal Enclosures
- Electric Components
- Solar Tracking Systems
- Solar Fences
- Solar Balcony Mounting Kits
- Road Barriers



+90 (222) 236 15 00  
percin.batum@kiracmetal.com  
info@kiracmetal.com  
www.kiracmetal.com





# ÖREN CABLES

## ABOUT US

Ören Kablo entered into cable manufacturing sector with the manufacture of coaxial cables in 1979. Making up its principle to determine its strategies by continually following up the demands of the customers and development of its competitors taking place in the coaxial cable market and segment since its establishment, Ören Kablo has always succeeded to make the best use of advance technology in product and service production to provide customer satisfaction and loyalty in rapidly changing business world. Ören Kablo entered into cable manufacturing sector with the manufacture of coaxial cables in 1979. Making up its principle to determine its strategies by continually following up the demands of the customers and development of its competitors taking place in the coaxial cable market and segment since its establishment, Ören Kablo has always succeeded to make the best use of advance technology in product and service production to provide customer satisfaction and loyalty in rapidly changing business world.

Carrying out its production activities in its modern manufacturing facilities located in Silivri Ortaköy Industrial Zone, Ören Kablo realising manufacturing wide range of products such as cable TV, digital satellite, data cables, interactive TV cables, CAT5, CAT6 LAN cables, signal command cables and fire warning cables; and at the same time, offers to the use of its customers the low fume and flame retarding versions of "halogen free" cable, which is also known as "fire proof cable" in the sector, for all the products taking place in this range.

## PRODUCTS AND SERVICES

- HD Series Coaxial Cable
- Signal and Control Cables
- Fire Alarm Cables
- Fire Resistant cables
- Data & LAN Cables
- Profibus Cables

Ören Kablo has CPR certificate for all cables in its production. Also, we have the following certificates for products and quality.

- Quality Management System Certifications,
- TSE and TSEK,
- TÜV Rheinland,
- VDE,
- Zero Waste Management System
- BSI,
- DNV Certificate,
- BV Certificate



+90 (212) 220 48 00  
ender@orenkablo.com  
sales@orenkablo.com  
www.orencables.com



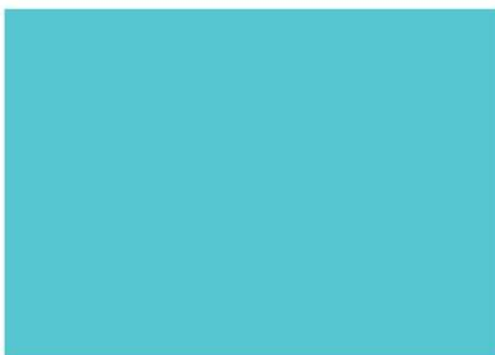

# PAMİR LIGHTING

## ABOUT US

We as Pamir Lighting, offering professional solutions about architectural and industrial lighting.

Fundamental principle of our firm is to produce and design quality, aesthetic and energy saving products. By doing detailed and creative R&D works, Pamir Lighting is become one of the pioneer and leader firm in its industry. Pamir Lighting is exporting its products 40 countries by being leader and consolidating Turkish Brand image in international arena.

After all this rigorous work, Pamir Lighting has industrial design certificate of incorporation for its products. Certificate prevents to imitate our products. Helps to maintain trust base relationship with customers.

Our company designs its products in a computer environment in order to provide the necessary aesthetics and functionality. Also, well developed R&D unit of the company can design products as wish of customer demands. On principle, we use quality components for our products and maintaining detailed labor in all production stages. Regardless of the quantity you ordered the same labor and daintiness are ensuring by us.

Be included in lighting industry and producing lighting fixtures about 40 years enable us to receive repeated orders from domestic and international customers. We see that 40 years' experience and repeated orders are the sign of our seriousness and quality.

We will be honored to know and serve you.

## PRODUCTS AND SERVICES

Range of products:

- LED lighting fixtures for offices and shopping places,
- IP65 LED Floodlights & High bay lights,
- IP65 LED and T8 Waterproof lighting fixtures,
- Downlights, Track Lights
- Glop lamps,
- Wall lamps,
- Motion sensor,
- Motion sensor lamps.



+90 (332) 355 86 16  
necdet@pamir.com.tr  
export@pamir.com.tr  
www.pamir.com.tr





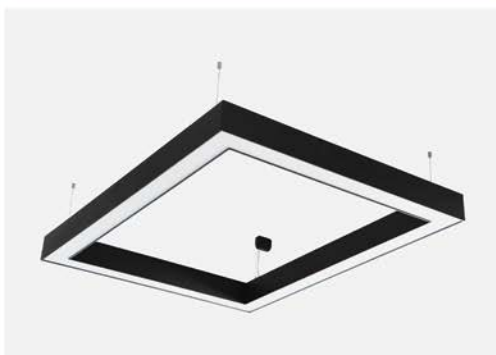

# SOLEN KABLO

## ABOUT US

Solen is brand new DC Solar Cable manufacturer with comprehensive know how in high tech equipped factory located 100 km away from Istanbul, Türkiye.

Solen is your reliable partner for approved quality DC Solar Cables.

- Producing only Solar Cables with TUV certificate.
- Young, dynamic and flexible.
- Extensive stock portfolio for 4 - 6 – 10 mm<sup>2</sup> cables.
- Offering the best quality with reasonable prices.
- Having both CE & UKCA - CPR rating – Dca class.
- Committed to philosophy being true partner with reputable references.
- Having product liability insurance certificate.
- Very soon we will have Electron Beam facility that is giving chemically, physically, electrically and pricing advantages.

To have more information please visit;  
[www.solenkablo.com](http://www.solenkablo.com)

## PRODUCTS AND SERVICES

- Solar DC Cables
- H1Z2Z2-K Cables



+90 (212) 238 75 63  
kubas@solenkablo.com  
info@solenkablo.com  
www.solenkablo.com



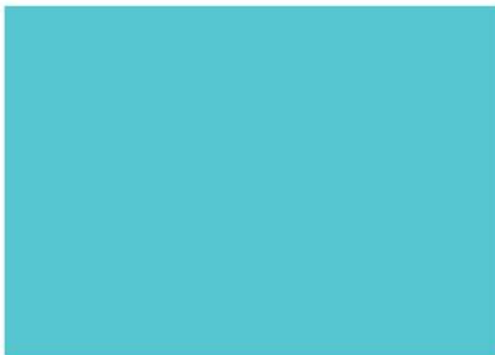

## ABOUT US

TEM Technical Electrical Materials Industry and Trade Inc. was established in 1989 to produce plugs & sockets and junction boxes.

We still pursue our operations to realize with the same targets. Our experience has placed TEM as one of the leaders of the market with our capacity to develop new products and our attention on following the growing market necessities.

Our range of products includes CEE NORM plugs and sockets, single phase plugs and sockets designed according to different standards, rubber plugs and sockets, combination boxes available on request, sealed thermoplastic junction boxes, plastic distribution boards, modular aluminum multi-sockets, cable pulleys etc.

We work with well-known brands in many countries. We export 60% mainly to the European region. Our biggest markets are France and Poland. The main categories of companies we work with are:

- Electrical supplies Distributors
- Electrical equipment wholesalers
- Rack Cabinet manufacturers
- Office furniture manufacturers
- Electrical equipment manufacturers

## PRODUCTS AND SERVICES

TEM Teknik is a manufacturer company specializing in the production of a wide range of electrical components and systems. Their extensive product line encompasses sockets, industrial enclosures, power distribution units, and office-specific socket groups. With a strong focus on quality and innovation, TEM Teknik is a trusted provider of essential electrical solutions for various sectors and applications.

Major product titles:

- Enclosures
- CEE Norm Plugs&Sockets
- Industrial Sockets
- Power Distribution Units
- Power Strips
- Office Sockets
- Wi-Fi Sockets
- IP-PDU



+90 (533) 266 82 12  
ali@temteknik.com  
www.temteknik.com



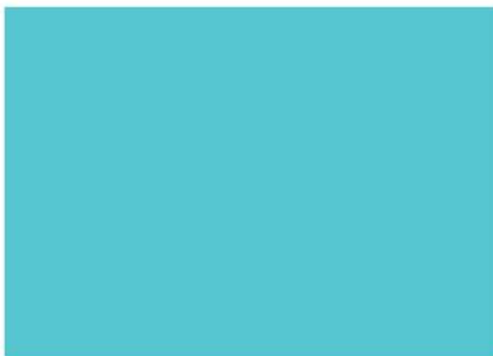
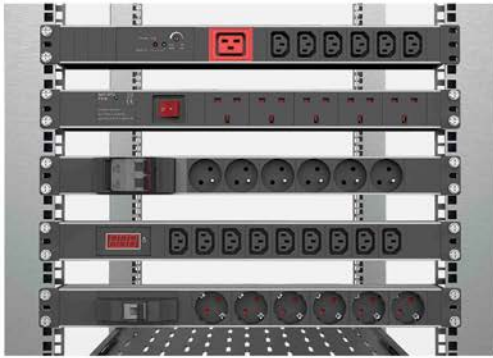

# TEMKA KABLO

## ABOUT US

TEMKA KABLO, started production in 1998, puts respect for the environment, human and labor as a fundamental principle in its production and marketing strategies by tracing the technologic developments as well.

By putting quality in the center, we enhance our product portfolio and track day by day. We will continue manufacturing coaxial cables, signal and control cables, telecommunication cables, data transmission cables, flexible control cables, fire resistant control cables, instrumentation cables and many special cables.

TEMKA CABLE has taken this qualification as a basic principle and has documented this principle with TSE-TSEK, ISO 9001: 2015, ISO 14001:2015, CE certificate etc. quality documents.

## PRODUCTS AND SERVICES

- Coaxial Cable
- CCTV Camera Cables
- Signal and Control Cables
- Fire Alarm Cables
- Fire resistant cables
- Telecommunication Cables
- Flexible Control Cables
- Data Transmission Cables
- Flat Cables
- Silicon Cables
- Instrumentation Cables



+90 (212) 689 90 90  
cerenbasak@temkakablo.com.tr  
www.temkakablo.com.tr



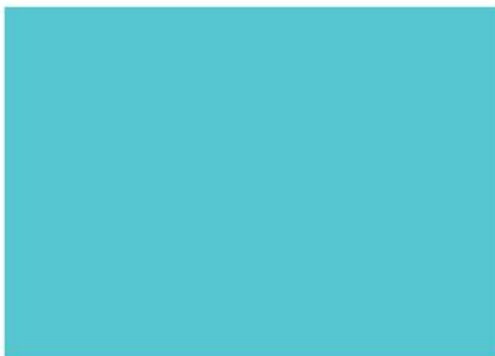
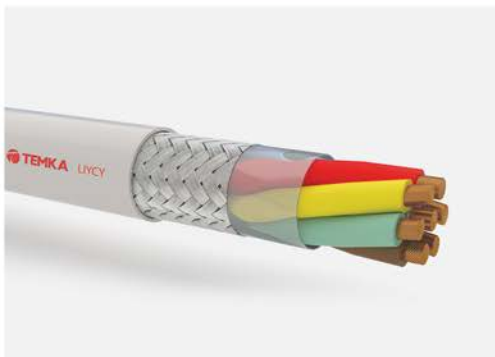

# TIMSAN TRANSFORMER

## ABOUT US

Timsan produces outdoor / indoor power transformers from 25 kVA to 30000 kVA in power and from 6 kV to 54 kV in voltage, oil immersed type, hermetic or open-atmosphere (oil expansion reservoir) and from 25 kVA to 20000 kVA Dry Type Cast Resin transformers. Timsan exports more than export to more than 70 countries electricity companies. The products are economical, highly efficient, and secure in accordance with the standards and lists of conditions in force.

## PRODUCTS AND SERVICES

- Power and Distribution Transformers
- Oil Filled Transformers
- Dry Type Cast Resin Transformers



+90 (535) 451 14 33  
✉ export3@timsantrafo.com  
🌐 <http://www.timsantrafo.com>







# TRANSFOMAX

## ABOUT US

TRANSFOMAX was founded in Şanlıurfa in 2006, in order to operate in domains of electricity, engineering, consultancy, and commitment.

Beginning its investments with the motto 'Quality is the Key for every door', our expert working team that is gathered together for transformer production, maintenance, and repair, and our Senior Staff which incorporates all kinds of technical faculties, have assumed their place in the industry within a professional business line.

TRANSFOMAX® ensures transformer products pursuant to demands of clients and dealers apart from the brands within the body of Transfomaks Transformatör Sanayi and Ticaret Ltd. Sti. , and continues its industrial and commercial activities via dealers in various countries.

## PRODUCTS AND SERVICES

Power and distribution  
Transformers:

We are manufacture three phase and single phase oil immersed transofmers that use in constant operations at outdoor and indoor places from 50 kVA up to 30 MVA .

Manufacturing Standards (IEC, ANSI, IEEE, CSA, TSE, VDE, ÖVE, BS ).

Product Types:

- Step-Down / Step-up Transformers
- Multi-Windings Transformers for various Industrial Applications
- Earthing Transformers
- Rectifier Transformers
- Solar Power & Windfarm Transformers

**transfomax**®

+90 (414) 369 11 35  
sales@transfomax.com  
www.transfomax.com



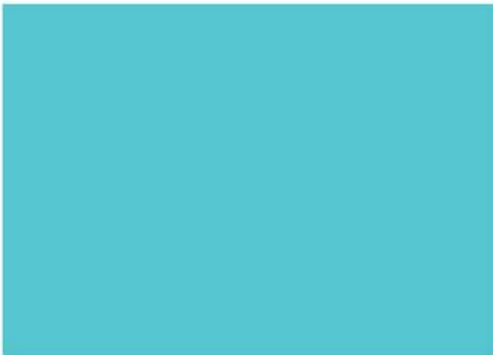

# NOTES

The page is designed for note-taking. It features a prominent teal header bar at the top. Below this, the entire page area is filled with a pattern of alternating light gray and white horizontal stripes, creating a guide for writing lines.

**Türkiye**

**Türkiye**



**Electrical and Electronics  
Exporters' Association**

**Phone** : +90 212 454 00 00  
**Fax** : +90 212 454 00 01

**info@tet.org.tr**    **www.tet.org.tr**

Yenibosna Merkez Mahallesi Sanayi Caddesi No:3 Dış Ticaret Kompleksi  
A Blok P.K.34197 Bahçelievler / İSTANBUL